

REHAUSSES HOPPER EXTENSION

Réf: 400 371 - 00 - EU / BD

 **X36**

 **X44**



Sulky Burel

BP 92111, rue Fabien Burel, 35221 Châteaubourg Cedex- FRANCE
Tél: (33) 02.99.00.84.84 - Fax: (33) 02.99.00.84.61

SULKYO 





e-mail : info@sulky-burel.com - Web: www.sulky-burel.com

X36

X44



30 min

H 8 x 25 inox	8 nylon	M 8 N inox	FREIN H8 INOX
			
1	2	3	4

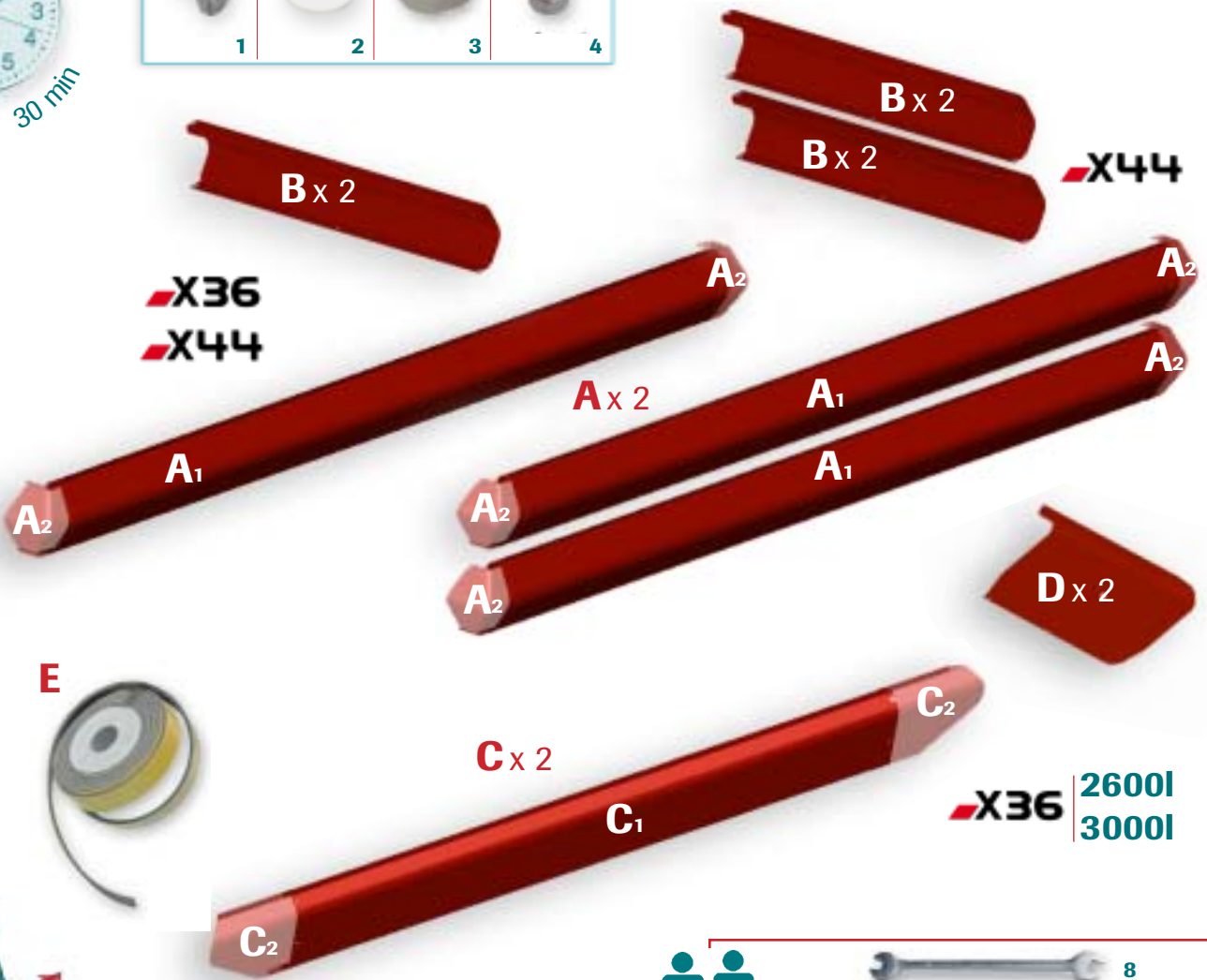

8

8

X36 2600l
3000l

1 — X 36 / X 44

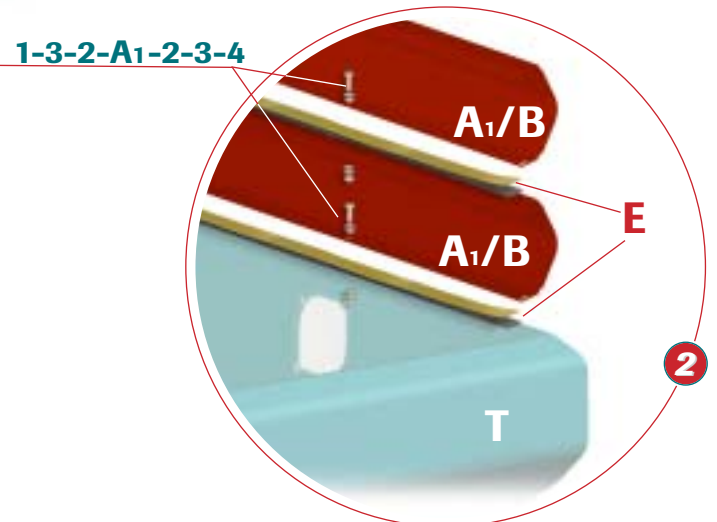
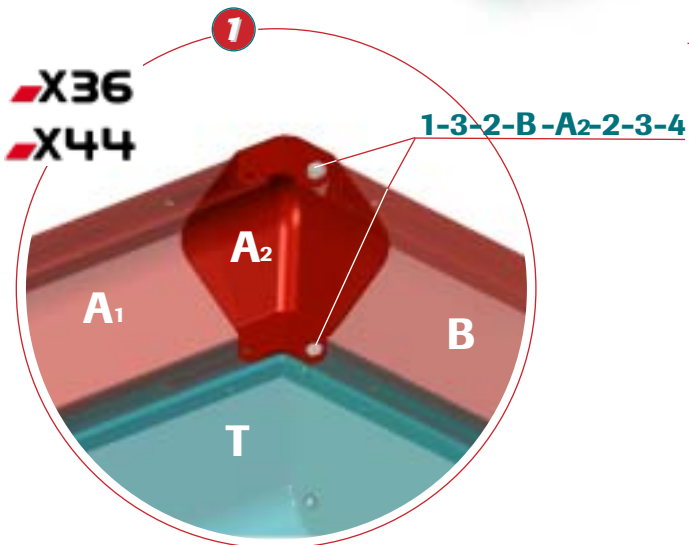
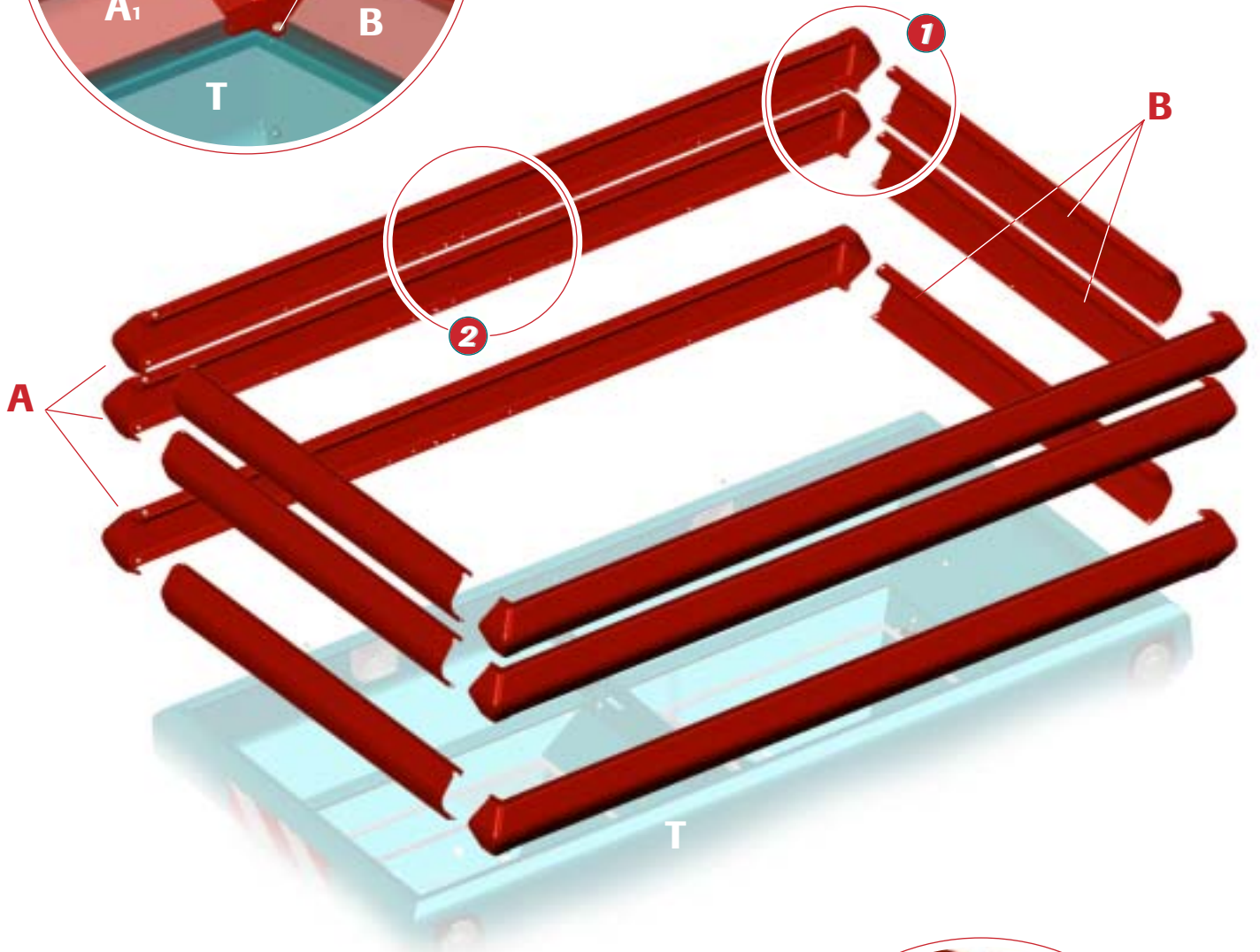
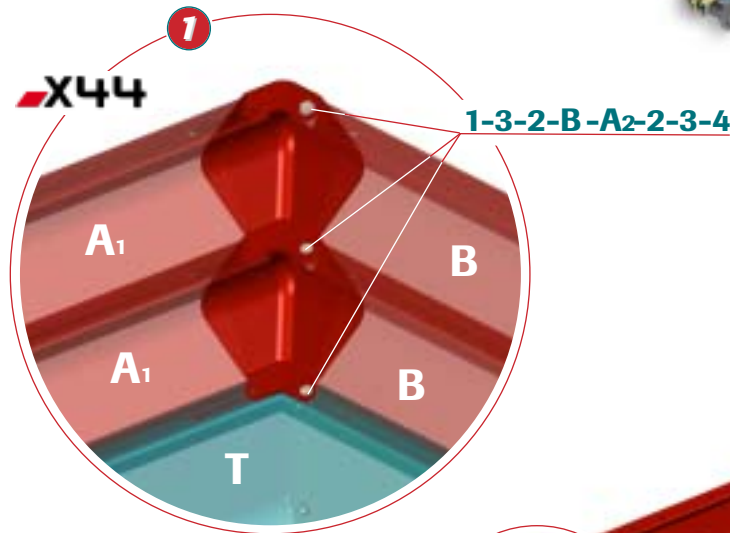
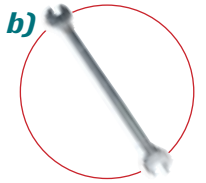

2 — X 36

2600l
3000l



1-3-2-C₂-D-2-3-4

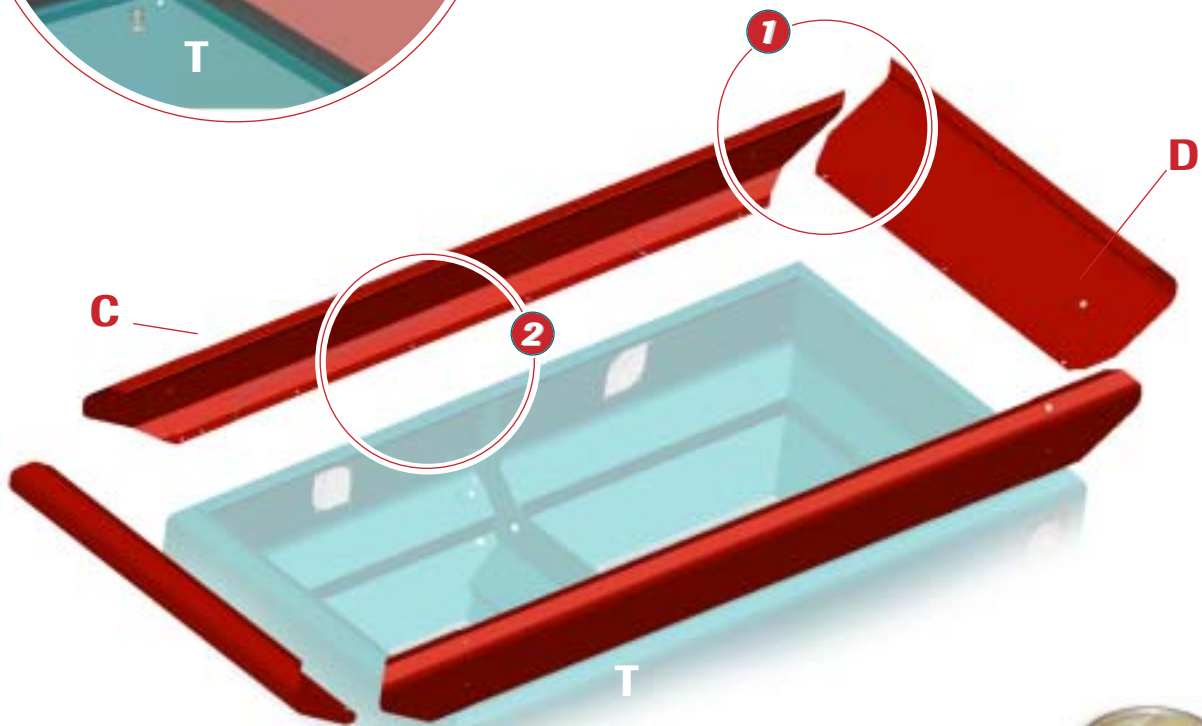
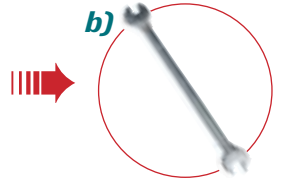
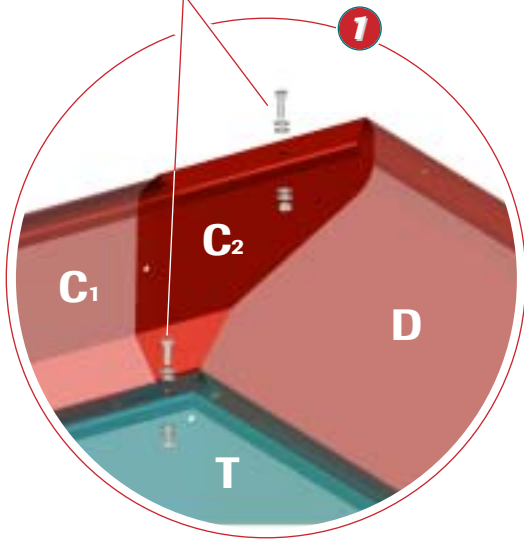

1-3-2-C₁-2-3-4

